



mellerware®

E X E C U T I V E
T E M P U R A 3 L D E E P F R Y E R



complies with
INTERNATIONAL
IEC60335
SAFETY SPECIFICATIONS

m
2000W

2 YEAR
GUARANTEE

Model:
27103

PLEASE READ ALL INSTRUCTIONS BEFORE USE

2 year guarantee





Dear customer,
Many thanks for choosing to purchase a Mellerware brand product. Thanks to its technology, design and operation and the fact that it exceeds the strictest quality standards, a fully satisfactory use and long product life can be assured.

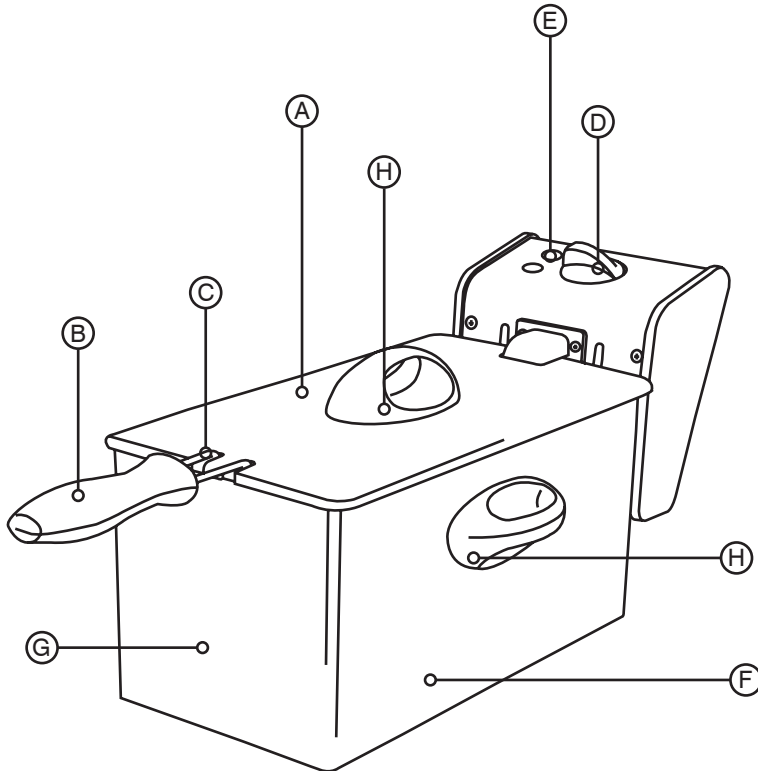

Description:

- A - Fryer lid
- B - Detachable basket handle
- C - Basket
- D - Thermostat adjustment control
- E - Temperature control pilot light
- F - Cooking pot
- G - Body
- H - Cool touch handles





BEFORE USE:

First read all the instructions before use and retain them for later reference. Only plug this appliance into an earthed wall socket.

- Before first use, remove all the packing materials: remove the protection films on the lid and outer case.
- Wash the accessories and the inner oil container in warm water. Dry well before use. Ensure that the electrical components remain dry. The appliance is equipped with an adjustable thermostat and indicator lamps.
- The “open” frying system ensures excellent professional results and allows for easy cleaning.

Important Safety Advice:

- Use the appliance in a well ventilated area.
- Keep the appliance away from any flammable material such as textiles, cardboard or paper, etc.
- **CAUTION:** In order to prevent overheating do not cover the appliance.
- Ensure that the voltage indicated on the rating label matches the wall socket voltage before inserting the plug into the wall socket.
- The appliance's plug must fit into the wall socket properly. Do not alter the plug. Do not use plug adaptors.
- Do not use or store the appliance outdoors.
- Do not leave the appliance out in the rain or exposed to moisture. If water gets into the appliance, this will increase the risk of electric shock.
- Do not use the appliance if it has fallen on the floor or if there are visible signs of damage.
- **CAUTION:** Do not use the appliance near water.
- Do not apply any additional force or tug on the power cord. Never use the power cord to lift up, carry or remove the plug from the wall socket.
- Keep any possible distractions well away from you when using the appliance as they may cause you to lose your concentration. Use common sense when operating the appliance. Do not use it when tired or under the effect of drugs, alcohol or medication. A moment of distraction while operating this type of appliance may result in serious personal injury.
- Children should be supervised to ensure that they do not play with the appliance.
- This appliance is for household use only. This appliance is not for industrial or commercial use.
- This appliance is not intended for use by persons (including children) with reduced physical, sensory or mental capabilities, or lack of experience and knowledge, unless they have been given supervision or instruction concerning use of the appliance by a person responsible for their safety.
- **Extreme caution** should be exercised when cooking with hot oil.
- Do not touch the plug, power cord or appliance with wet hands.
- When the appliance is not in use, turn the thermostat control dial to the “MIN” setting and remove the plug from the wall socket.
- **CAUTION!** This appliance becomes extremely hot during use. Handle with care.





HOW TO OPERATE THE APPLIANCE:

This type of fryer may only be used with oil or liquid fat, and is not suitable for use with solid fat. Solid fat may contain water, which can cause hot fat to splash when heated.

- Never switch on the appliance without oil or fat as this could damage the element. Also, do not place any other liquids such as water or other substances in the oil container, only cooking oil or liquid fat.
- Place the appliance on a dry, flat and stable surface.
- The appliance becomes hot during use, ensure that the appliance is used away from surrounding objects or any flammable materials.
- Remove the lid from the appliance and take out the accessories.
- Fill the appliance with the desired amount of oil or fat. Ensure that the appliance is filled above the “MIN” level and below the “MAX” level as indicated on the inside of the oil container. Do not mix different cooking oils.
- To select the correct temperature for the type of food to be fried, consult the “**FRYING TABLE**”. Place the food to be fried into the basket.
- For best results, put dry food into the basket.
- Use the handle to place the basket in the oil container.
- Lower the basket into the oil slowly to prevent excessive bubbling or splashing. **EXERCISE EXTREME CAUTION WHEN LOWERING THE BASKET INTO THE HOT OIL.**
- The pilot light will switch off to indicate the temperature selected has been reached. Always wait until the selected temperature has been reached before you lower the basket into the oil. The pilot light will switch on & off during the frying process to maintain the temperature of the oil.
- Remove the basket from the oil once the food has been fried.
- Allow oil to drain off, by mounting the basket on the edge of the oil container via the bracket on the basket.
- If the appliance is no longer required, turn the thermostat control dial to the “MIN” setting and remove the plug from the wall socket.
- Clean the basket with soapy water after use, then rinse and dry thoroughly.
- Once the appliance and oil has completely cooled down, place the basket in the appliance and store it.
- To place the handle inside the basket, hold the basket firmly with one hand and use the other hand to push the handle. The handle will unclip and fold downwards.
- Store the appliance, with the lid closed, in a dark, dry place. If the oil can still be reused, store the oil in separate container.
- Do not use the same oil more than three times.

FRYING TIPS:

- Use a maximum quantity of 200 grams of French fries per litre of oil.
- With frozen products, use a maximum quantity of 100 grams as the heat defrosts the food in a short period of time. With frozen food, remove as much ice/frost as possible before submerging it into the hot oil.
- When using fries made from fresh potatoes: dry the fries thoroughly to remove as much water content as possible before submerging into the hot oil.
- For frozen fries, deep-fry the fries in 2 stages. First stage (pre-frying): 5 to 10 minutes at 170°C. Second stage (final frying) 2 to 4 minutes at 190°C. Drain well.





TYPE OF FOOD	FRYING TEMPERATURE (°C)
Pre-frying of fries	170
Final frying of pre-fried/normal fries	190
Fondue parmesan	170
Cheese croquettes	170
Meat/fish/potato croquettes	190
Fish	150
Fish sticks	180
Cheese fritters	180
Doughnuts	190
Meat croquettes	190
Chicken	160
Scampi fritters	180

TO REPLACE THE OIL:

Ensure that the appliance and the oil have cooled down completely before replacing the oil (remove the plug from the wall socket). Replace the oil regularly. Oil needs to be replaced if it becomes dark, or emits a different odour. Replace the oil after 3 cycles of continuous use. Replace the used oil, do not mix used and fresh oil. Incorrect disposal of used oil is a threat to the environment. Consult with your respective municipal waste collector in your area about the correct procedure for the disposal of used oil.

CLEANING AND MAINTENANCE:

- Always allow the appliance and oil to cool down before undertaking any cleaning task.
- Clean the inner & outer surfaces of the appliance regularly to keep the appliance in a good working condition.
- Clean the outer surface of the appliance with a soft damp cloth & a few drops of washing up liquid. Rinse with a clean, soft damp cloth and dry with a soft, clean cloth.
- Do not use solvents, or products with an acid or base pH such as bleach, or abrasive products, for cleaning the appliance.
- The basket and the handle can be cleaned in warm, soapy water. Dry well before using again.
- When replacing the oil, clean the oil container as well before inserting fresh oil. Empty the oil container and clean the inside with a paper towel. Then use a cloth dipped in soapy water to further clean the oil container. Then wipe with a damp cloth and dry thoroughly.
- All components, besides the heating element assembly, power cord and plug, may be cleaned in warm soapy water. Dry thoroughly before use.
- These components may not be cleaned using a dishwasher machine.





TIPS:

- Always place the appliance on a stable surface and keep away from all flammable materials.
- Ensure that the appliance is not used on or near any other heat source.
- Before you use the appliance it must be filled with the required amount of oil or fat. Never use the appliance without oil or fat because this will damage the heating element.
- Never move the appliance during use. The oil temperature reaches severe heat levels and could cause serious injury. Wait for the oil & appliance to cool down completely before you move the appliance.
- This appliance is protected with a thermal safety device, which switches the heating element off automatically if it overheats. To reset the appliance, remove the plug from the wall socket and allow the heating element to cool down completely. Press the reset button on the reverse side of the heating element assembly. Then insert the plug into the wall socket and switch on the appliance.
- Never immerse the heating element assembly in water.
- Never leave the appliance unattended while in use. Ensure that children remain as far away as possible from the appliance during use.
- If the appliance or power cord is damaged, return the appliance to the nearest authorised service centre for repair.
- Do not try to repair the appliance or to replace a damaged power cord. Any attempt to dismantle or repair the appliance renders the warranty and the manufacturer's liability null and void.
- Be sure not to damage the heating element.
- Before switching on the fryer, ensure that the element assembly is correctly and securely mounted in the slots on the stainless steel body. If the safety switch is not engaged, the heating element will not switch on.

OVERHEAT PROTECTION:

- If you should accidentally switch on your deep fryer when there is no oil or fat in it then the overheat protection will automatically turn on. The appliance will not be usable and needs to be unplugged.
- Only after the device has been left to cool down completely should the "RESET" button on the rear of the heating element assembly be pressed for the appliance to work again.

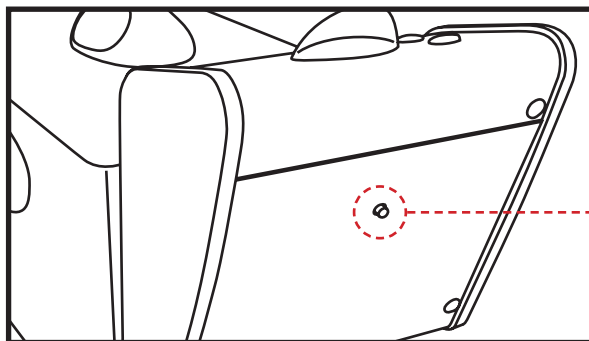

Reset button shown at the rear of the heating element assembly.

TECHNICAL DATA:

Operating voltage: 220-240V~50Hz
Power: 2000W







creative housewares

 20 Tekstiel Street, Parow, Cape Town, 7493, South Africa

 P.O. Box 6156 Parow East, 7501, South Africa

 +27 21 931 8117  +27 21 931 4058

Service Centre Helpline: 086 111 5006

 www.creativehousewares.co.za

